

VOL. 11

\$2.00

THE
STAR FLEET
HANDBOOK



- KZINTI
- CAITIANS
- THOLIANS

STAR FLEET HANDBOOK

CONTENTS

PAGE

Kzin/Kzinti	1
Kzin (front and rear views)	2
Kzinti Police Vessel (diagram)	3
Kzinti Police Vessel (particulars and cross section)	4
Cait/Caitians	5
Caitian (front and rear views)	6
Tholian Assembly	7
Tholian Space Cruiser (particulars)	7
Tholian Space Cruiser (diagram)	8
Hand Laser - Early Model	9

Copyright © 1977 by Interstellar Associates 

THE STAR FLEET HANDBOOK - edited and published (approximately bimonthly) by:
Geoffrey Mandel, 201 W. 16th St. (Apt. 20A), New York, NY 10011

subscriptions (and renewals): 8/\$3.50 postpaid
sample copies: 50¢ + 15¢ postage

The only back issues available are Vol. 10 and the special ALIENS OF STAR TREK issue,
\$1.50 + 25¢ postage (mailed flat)

Contributions (especially articles and artwork on STAR TREK's characters, aliens and
technology) are welcome. Contributors receive a free copy of the issue in which their
submission appears.

What your address label tells you:

- * - subscription expires this issue
- S - sample or UNISTAR membership copy
- C - complimentary copy
- # - number of issues left in subscription

ACKNOWLEDGEMENTS

Hand Laser diagram and Tholian Space Cruiser diagram and particulars are by George
Perkins.

Views of Kzinti were taken from filmclips courtesy of Jeff Maynard (of NEW EVE STUDIO,
P.O. Box 10193, Elmwood, CT 06110, dealer in select and unusual STAR TREK items).

Helpful in compiling this issue were the storyboard of "The Slaver Weapon" and THE STAR
TREK COLORING BOOK, available from: LINCOLN ENTERPRISES, P.O. Box 69470, Los Angeles,
CA 90069

Kzinti appeared on STAR TREK in the animated episode "The Slaver Weapon" by Larry Niven,
based on his non-ST short story "The Soft Weapon". This in turn is part of Niven's
"Known Space" series of four novels and a number of stories. Some information on Kzinti
in this issue is from Ringworld, Neutron Star (containing "The Soft Weapon") and Tales of
Known Space (all available from BALLANTINE BOOKS).

Some information on Tholians is from THE STAR TREK CONCORDANCE.

KZIN



The Kzinti planets are located on the border of United Federation space. Kzin itself is an Earth-like world, but with slightly higher gravity. A Kzinti year is equal to 343 days.

KZINTI

The Kzinti, although felinoid, resemble the Caitians only vaguely. Males are massively built (heights to 2.5 meters and a mass of over 25 kilograms are not uncommon) and have much broader features than Caitian males. Kzinti females are similar to Caitians, although slightly larger; but unlike Caitians, they are dumb animals. This results from the inveterate physical dominance of the males, whereas with the smaller and more intelligent Caitians the females were allowed to develop as sentient beings.

Kzinti fur is orange rather than the Caitian gold; the males have darker red markings around the eyes. The Kzinti auricle can be folded up like an umbrella to protect the inner ear; also, the pupils are round rather than slitted. The tail is hairless, and the nose and mouth are wider than a Caitian's. A Kzinti rictus is not a smile; rather, it is an expression of anger.

The Kzinti are ferocious fighters, tremendously strong; they are descended from plains cats, and retain the strength, cunning and predator instincts of their ancestors. Kzinti are carnivorous, and prefer freshly-killed meat at body temperature. They have been known to eat human flesh.

HISTORY

For millenia, Kzin was the seat of a wide-spread empire based on a slave economy and the maintenance of terror (much like that of the ancient Slavers, the Vegan Tyranny, and the present-day Klingon Empire). Kzinti ships had the Gravity Planar, a limited interstellar drive, while most of the slave worlds had not even rudimentary space travel.

Kzinti scouts discovered Sol system in Earth year 2051, the first alien race to contact Man. Earth at that time had only primitive interplanetary spaceflight, and was unprepared to meet the invading Kzinti forces. Their telepaths reported a race (by Kzinti standards) given over entirely to peace, and the Kzinti slowly but steadily wore away at Earth's defenses. The First Man-Kzin War was cut short when Zefram Cochrane developed warp drive; the new starships easily outmaneuvered the Kzinti fleet. They were amazed and hurt, but continued to attack again and again. The Kzinti fought Earth four times, and each time more of their population and slave worlds were lost. They have a tendency to attack before they are quite ready; they have little concept of patience, and no concept of mercy or of limited warfare. The Fourth Man-Kzin War ended 200 years ago with the Treaty of Sirius; it grants the Kzinti probationary status, and allows them no weapons other than police vessels.

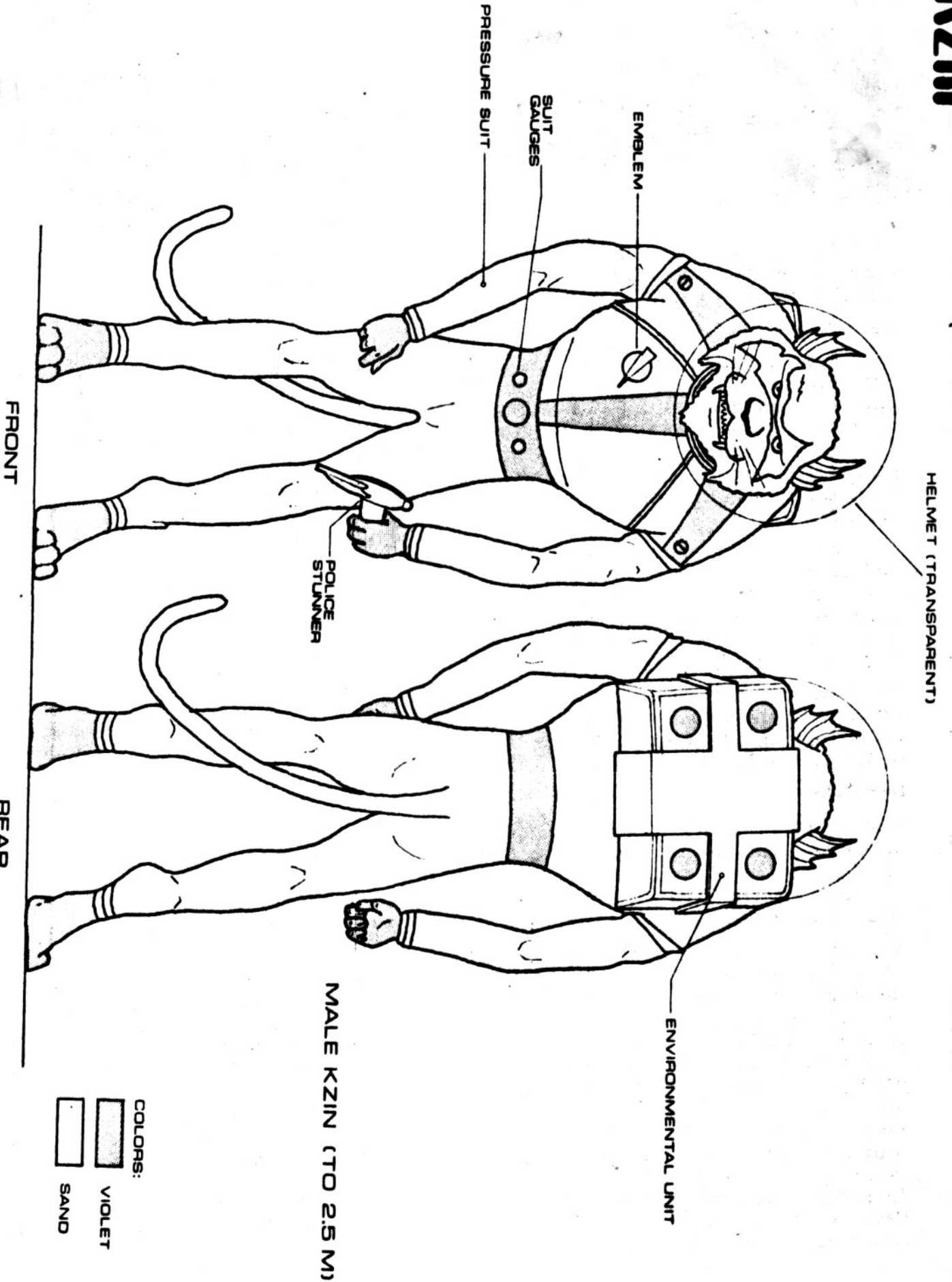

Kzinti POLICE VESSEL

DIAGRAM

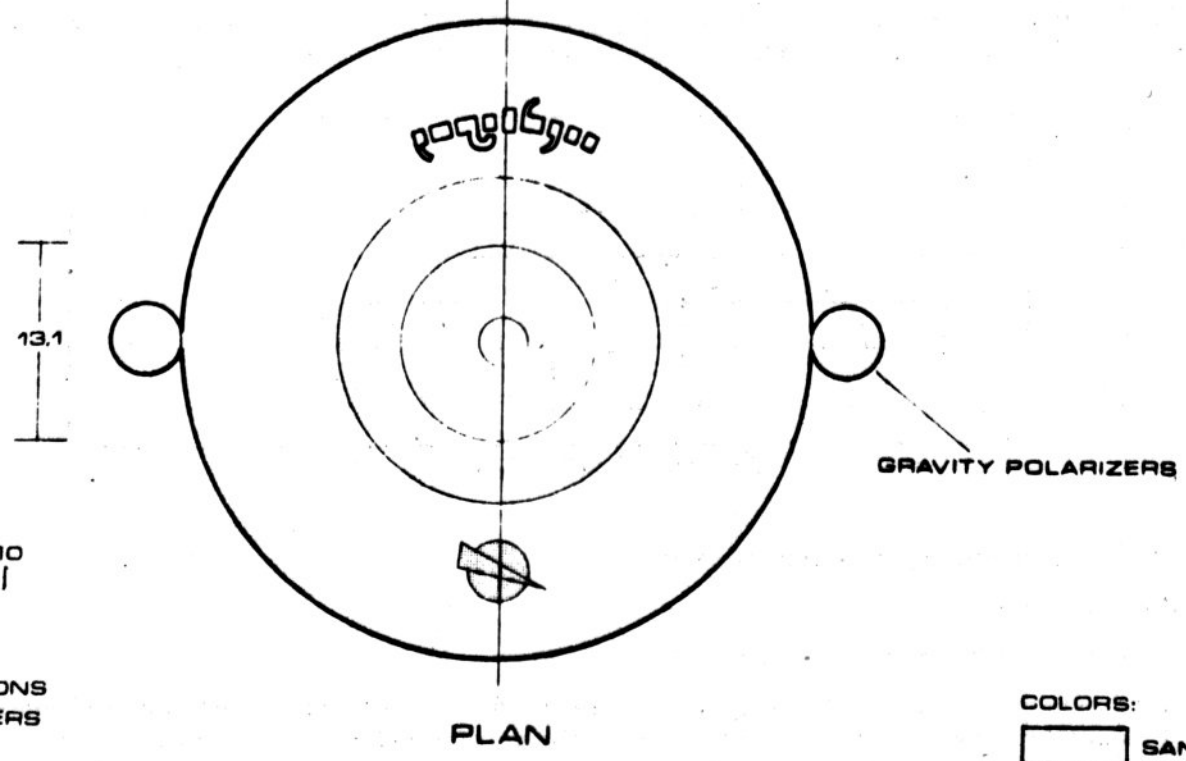
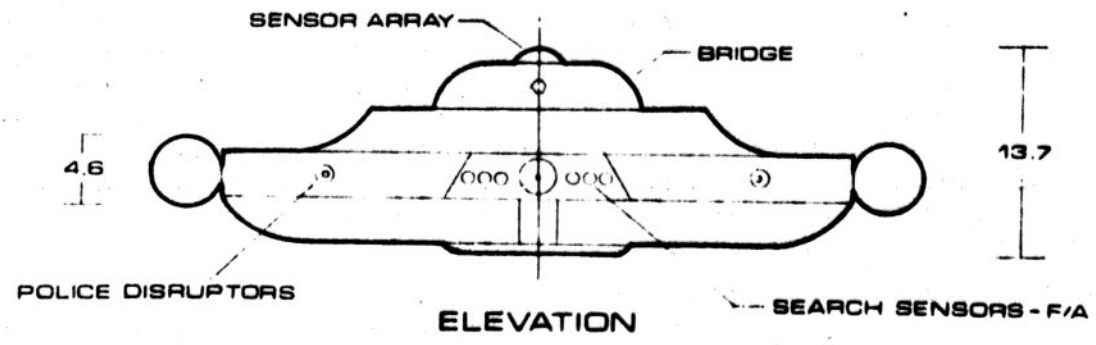
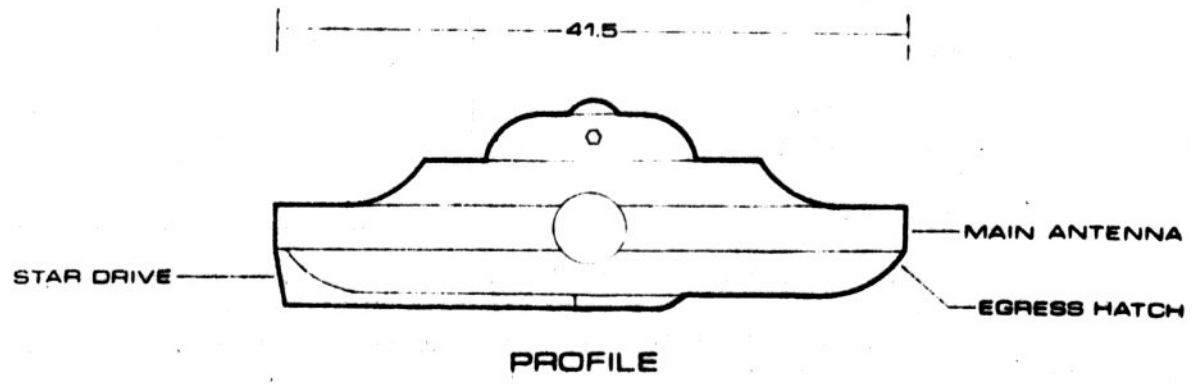

ALL DIMENSIONS ARE IN METERS

COLORS:
[] SAND
[] YELLOW

Kzinti POLICE VESSEL

"PATRIARCH" CLASS COURIER TYPE

PARTICULARS:

Gross Weight: 2,900 Metric Tons
Crew Complement: 16
Cruising Speed: Warp 6
Propulsion: Dual Hyperdrive Engines
Dual Gravity Polarizers
Armament: Police Disruptors

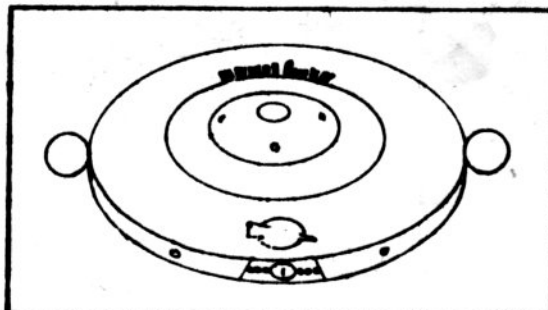

Under the terms of the Treaty of Sirius, the Kzinti are allowed only police vessels such as the "Patriarch" Class. This type is equivalent to the Federation Courier Class (used primarily for transport of diplomatic and command personnel), and provides a fast, highly-maneuverable pursuit craft.

The Hyperdrive (Star Drive) engines in this vessel are of Kzinti design, a variation of conventional Warp Drive. The dual Gravity Polarizers generate antigravity for planetary take-off and landing maneuvers (Kzin ships have long used antigravity in the Gravity Planar, a slower-than-light but highly efficient interstellar drive; it was probably developed from a Slaver flying belt similar to the one found in a stasis box by Earth scientists). Armament consists of Police Disruptors (the Treaty forbids them phasers), capable of disabling most classes of vessels. Search sensors fore and aft supply long-range surveillance. Typical restraint devices used by Kzinti vessels include police stunners and police webs.

Only two major violations of the Treaty have been made: two years ago, a Kzinti warship with disruptor banks on full power attacked the Heavy Cruiser U.S.S. Hood, destroying its bridge; and more recently, the privateer "Traitor's Claw" (listed on Kzinti records as stolen) held three officers of the U.S.S. Enterprise shuttlecraft "Copernicus" captive on a planet of Beta Lyrae while testing a new weapon found in a stasis box.

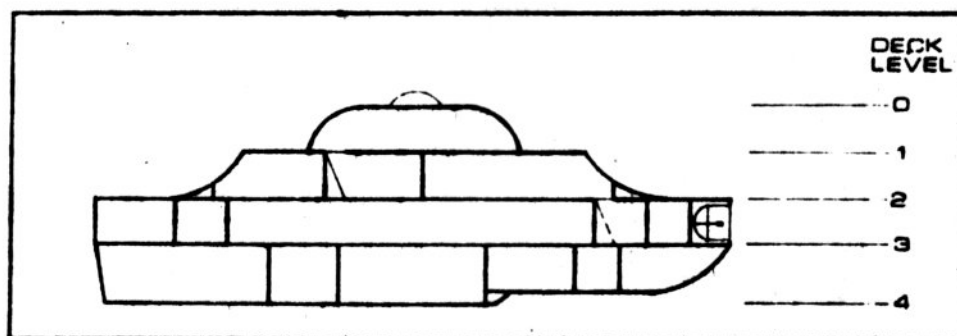

DECK
LEVEL

CROSS SECTION

- | DECK LEVEL | |
|------------|---|
| 0 | Navigation and Space Sensor Array |
| 1 | Control Room |
| 2 | Quarters, Officers' Relaxroom |
| 3 | Main (Directional) Antenna, Search Sensors, Forward and Rear Surveillance, Disruptor Banks, Life Support, Batteries, Water-Waste Reconversion, Materials Reclamation, Crew's Relaxroom |
| 4 | Airlock, Small Arms and Pressure Suit Stowage, Water Storage, Water Pressure and Pump Machinery, Refrigerated Food Storage, Food Preparation, Ship's Laundry and Repair Shop, Raw Materials Storage, Hyperdrive Engines, Engineering, Computers, Mess Room, Science Lab |

CAIT

Cait circles 15 Lyncis, a yellow binary star in the Lynx constellation; there is one other planet in the system, and it is uninhabited. The mass, atmosphere and gravity of Cait are all near Earth normal.

CAITIANS

Natives of Cait (Caitians) are feline - roughly human in appearance, but descended from felines rather than primates. They tend to be small (rarely over 1.8 meters) and sinewy, reminiscent of the Siamese and Abyssinian cats of old Earth. Physically, they differ from other humanoids in their golden fur (the females have a darker caramel-colored mane that is now often cut and worn in Terran style) and other feline attributes: a tufted tail, retractile claws, highly developed senses of sight, smell and hearing.

HISTORY

The Caitians share genetic roots in the far past with the warlike Kzinti (much as do the Vulcans and Romulans), although the two races have gone their separate ways to develop into entirely different civilizations. There is also some evidence to support the theory that both the Caitians and the Kzinti are descendants of the ancient Vedala, the oldest space-going race known to Federation science.

CAITIAN SOCIETY

Caitians are fierce warriors when aroused, but pride themselves on their accomplishments in arts and philosophy rather than in the martial arts.

Natives of Cait are strongly family-oriented - their family units are extremely close (a Caitian calls his siblings "litter mates" although they may not actually be of the same litter) and can often be traced back many generations. Members of a family share a common prefix in their names (for example, M' in the name M'ness). Typical of Caitian names are:

M'mar, M'nass, V'rrone, M'rest, D'irraj, M'sitt, N'nance, M'nault and M'turr.

Cait is a member of the United Federation of Planets, a major center of trade and commerce. Many Caitians are employed in various capacities with Star Fleet.

(continued from page 1)

KZINTI SOCIETY

The Patriarch or Highest of Kzin (of the Rait family) is the absolute ruler of the dozen-odd Kzinti worlds, and the chief on the anachronistic war council. Only those of noble family (or, formerly, those who have earned it as conquest leaders) are entitled to bear names - typical are Harch, Ftanss, Hroth, Kchula and others pronounceable only in the Kzinti language, the Hero's Tongue. Kzinti of lower family are stylized by their professions: Captain, Flyer (pilot), Telepath, Speaker-to-Animals (interpreter) and so on. Certain respected Kzinti are granted partial names by the Patriarch, as Chuft-Captain.

About one Kzin in a thousand is able to take a certain drug (a sthondat extract) which develops innate telepathic abilities, making it possible to read the minds of alien beings and other Kzinti. These trained telepaths (forced addicts of the drug) are unhappy neurotics, lean and bedraggled in appearance, often forced to join their minds with herbivores and other life forms repugnant to a Kzin.

Caitian

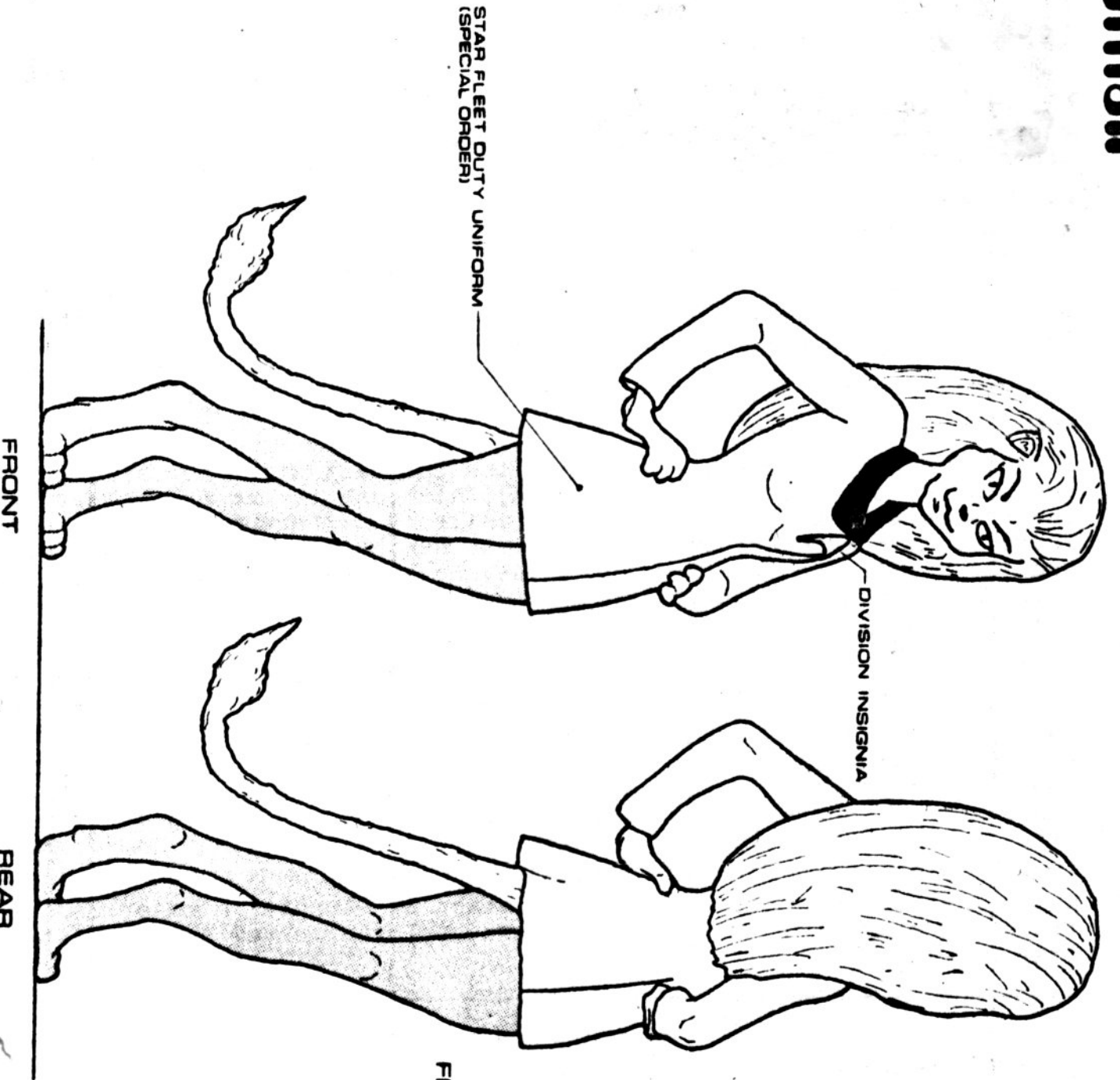

FEMALE CAITIAN (TO 1.7 M)

- COLORS:
- BLACK
 - NUDE
 - TENNE/BLUE/RED

THOLIAN ASSEMBLY

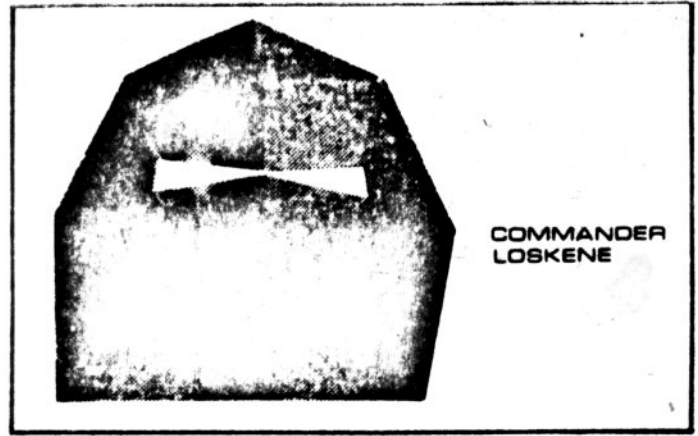

COMMANDER
LOSKENE

Tholia, the home system of the Tholian Assembly, lies on the periphery of Federation space. The Territorial Annex of the Tholian Assembly encompasses a region of space marked on Federation star charts as the Tholian sector.

The Tholians are known only slightly to the Federation, although they have acquired a reputation for punctuality. One current theory is that they are hot-planet beings, crystalline in composition rather than organic, possibly with a hive-culture or even a hive-mind.

In appearance, Tholians are a glowing red-gold in color, sharply angular; the only visible features are triangular white eyespots. The universal translator approximates their voice as harsh and grating. Unlike humans, Tholians do not seem to be affected by the proximity of interspace.

The only Tholian-Federation incident to date occurred on Stardate 5693.2, when Loskene, the commander of a Tholian vessel, fired upon the U.S.S. Enterprise after it was accused of trespassing into Tholian space.

Tholian SPACE CRUISER

SCOUT CLASS I

PARTICULARS:

Gross Weight:	750 Metric Tons
Crew Complement:	4 officers 18 crew
Standard Range:	6 years at .19 x c
Max. Safe Cruising Speed:	.51 x c
Emergency Speed:	.997 x c
Propulsion:	6 Ion Engines, 2 each Dorsal
Armament:	Phaser-like Disruptor Tractor Field Energy Filament

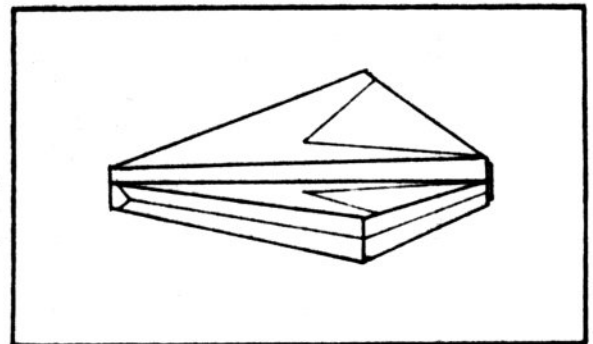

The Scout Class I space cruiser is a small spacecraft with limited capability. It is normally restricted to the Tholia system in range, but it can patrol beyond the system on long missions. In comparison with the primitive sub-light drive, the ship's weaponry is extremely effective - at close range, the phaser-like disruptor is more powerful than the Klingon counterpart. The energy filament requires two ships in tandem - it is woven into a geodesic sphere (or "web"), which acts as a tractor field and effectively immobilizes an enemy vessel caught inside. The cruiser's shielding is comparatively weak - a Federation Starship can knock it out at the first attack.

Details of internal arrangement are unknown.

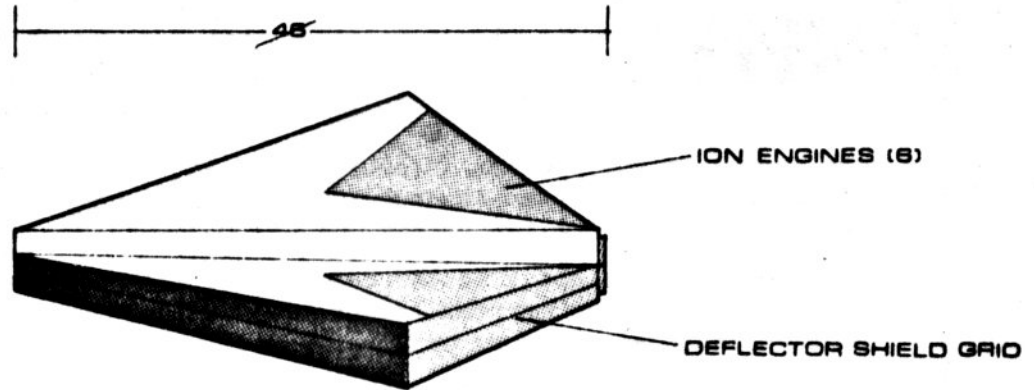

PROFILE

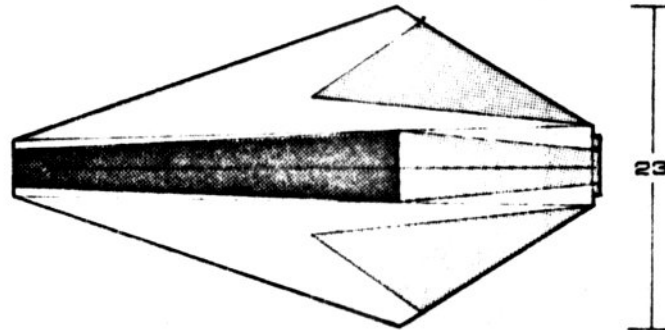

PLAN

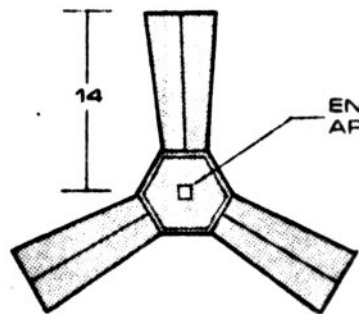

STERN

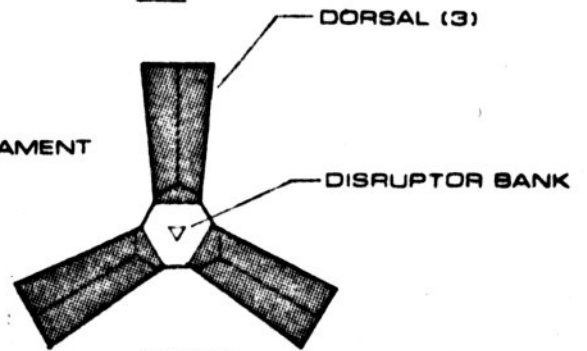

BOW

ELEVATIONS

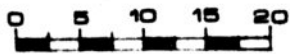

ALL DIMENSIONS ARE IN METERS

TYPICAL COLORS:

	WHITE
	BLUEGRAY
	RED

HAND LASER - EARLY MODEL*

*USED UNTIL STARDATE 1313.8

SIDE VIEW

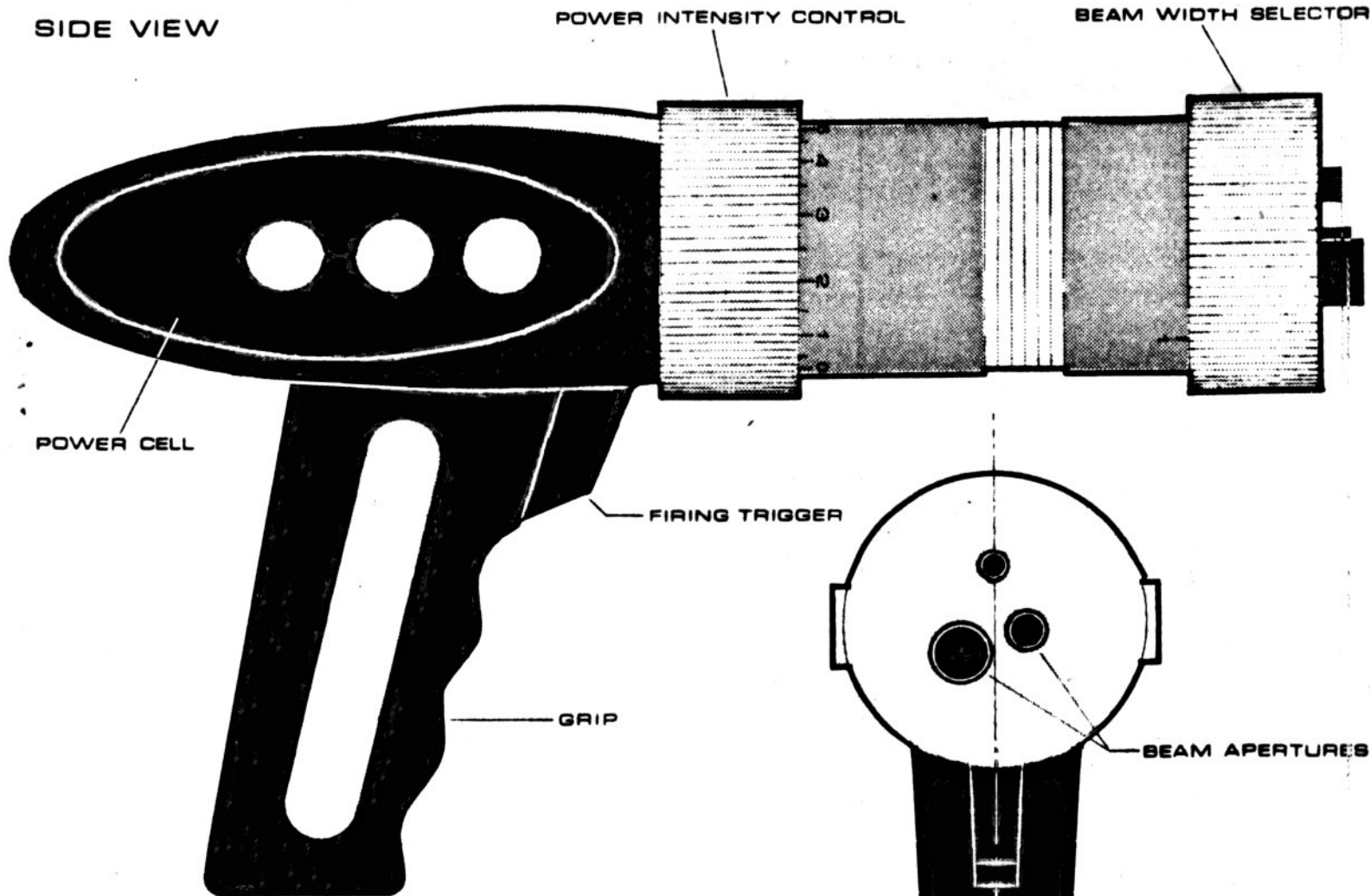



FRONT VIEW

DIMENSIONS:

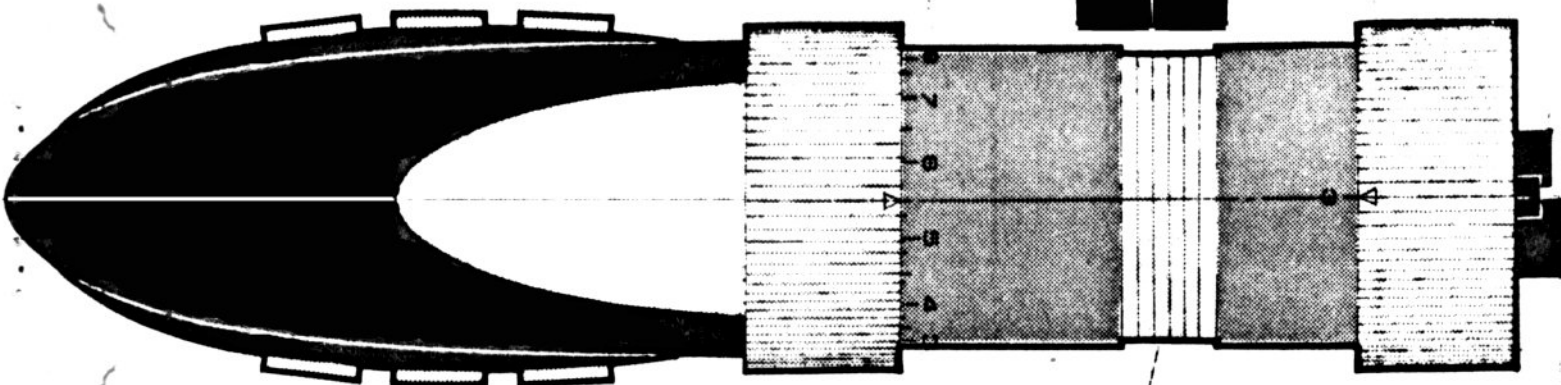
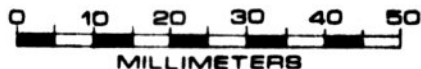
LENGTH OVERALL _____ 202 MM
WIDTH OVERALL _____ 48 MM
HEIGHT OVERALL _____ 121 MM

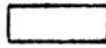

COLORS:

-  SILVER
-  RED-BROWN
-  BLACK

TOP VIEW